

Installation instructions for PZ4AL-03803-00, PZ4AL-03804-00  
Under Run Protective Shield Engine Bay and Transmission Case

## LEXUS UX



Model year:

**UX - 2018**

Applicability:

MZAA10L-AWXBBW  
MZA15L-AWXBBW

Part Number:

Steel: PZ4AL-03803-00  
Aluminium: PZ4AL-03804-00  
Installation kit: PZ4AL-03009-60



Weight:

Steel: 9,95 kg  
Aluminium: 7,01 kg



Installation Time:

30 min

**A**

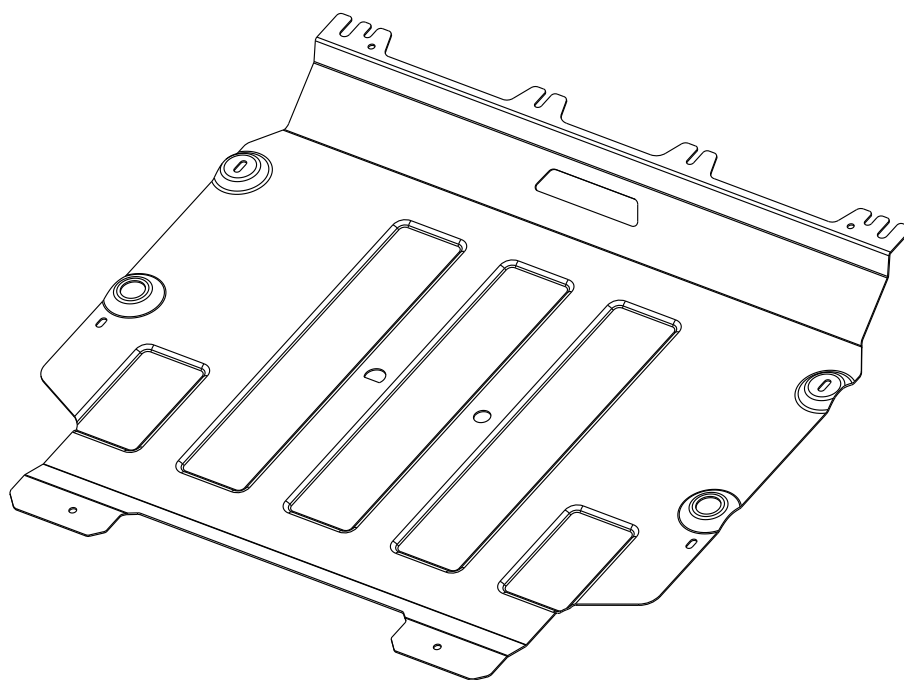

PZ4AL-03009-60

**B**

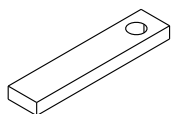

4x

**C**

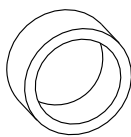

h=10 2x

**D1**

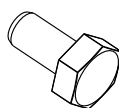

M6x30 4x

**D2**

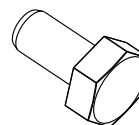

M8x20 2x

**D3**

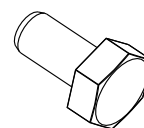

M8x30 2x

**E1**

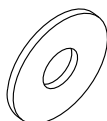

d=6

4x

**E2**

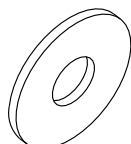

d=8

4x

**F1**



d=6

4x

**F2**



d=8

4x

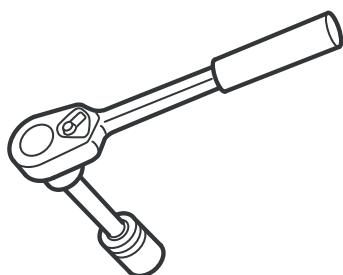

10 mm  
13 mm



1

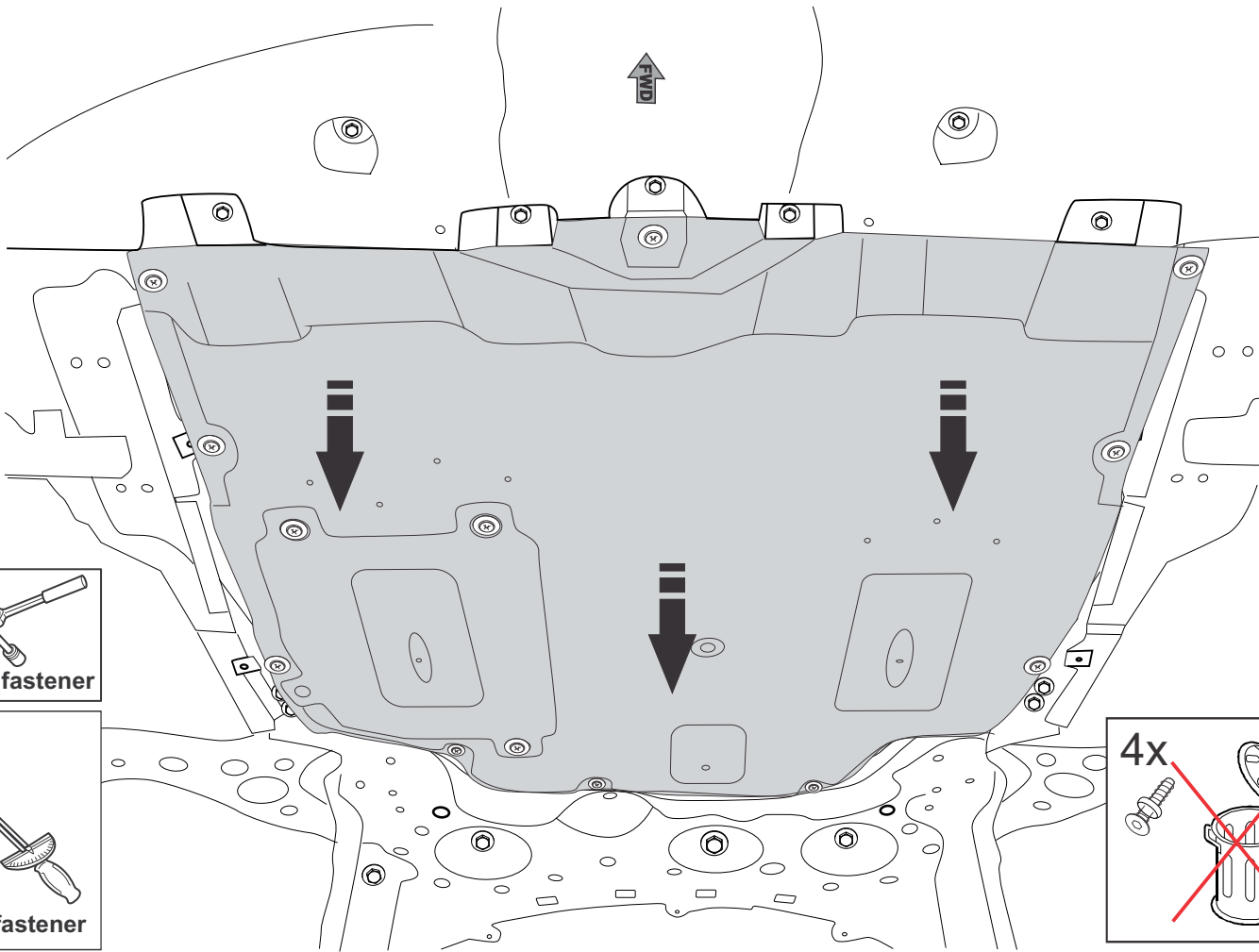

2

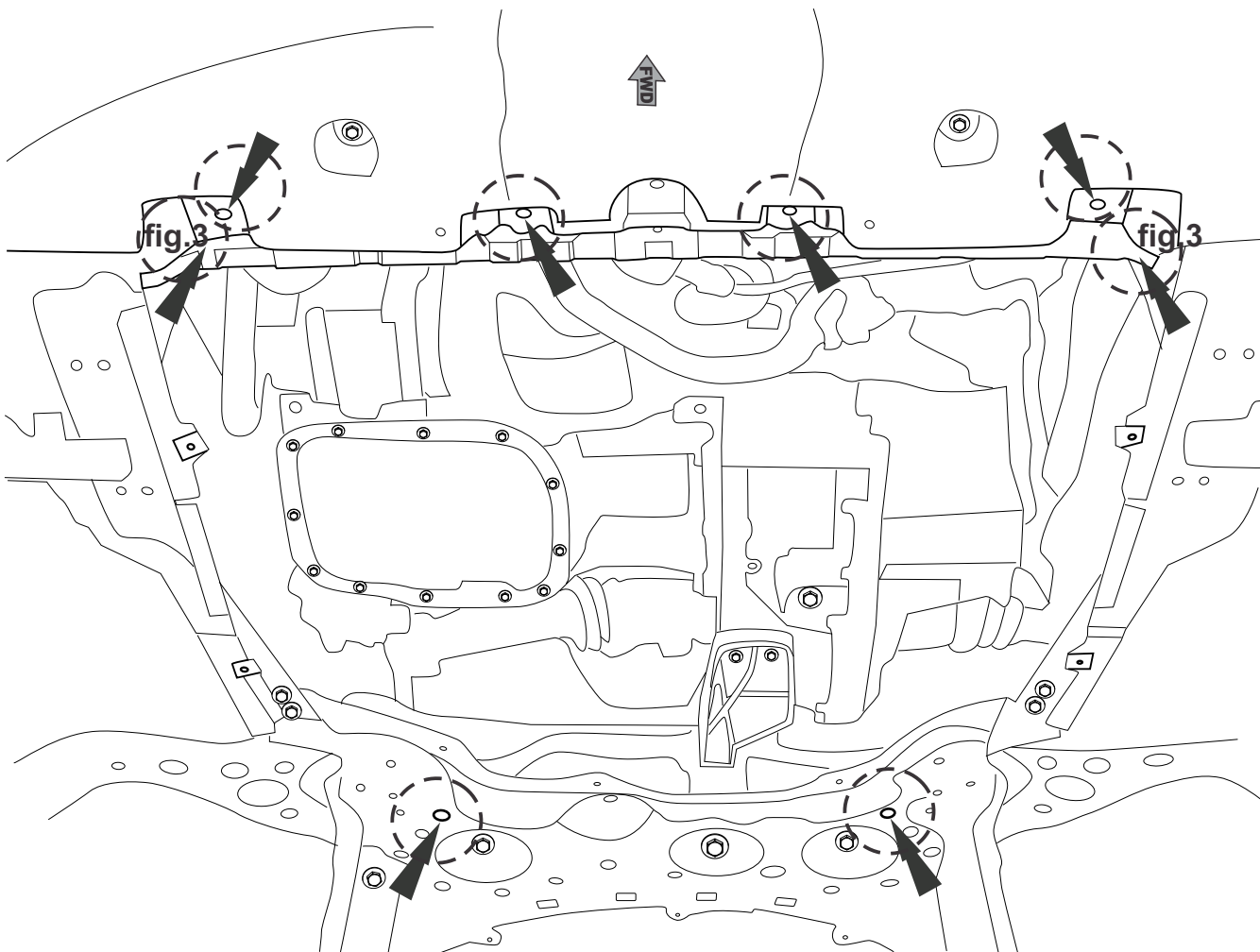

3

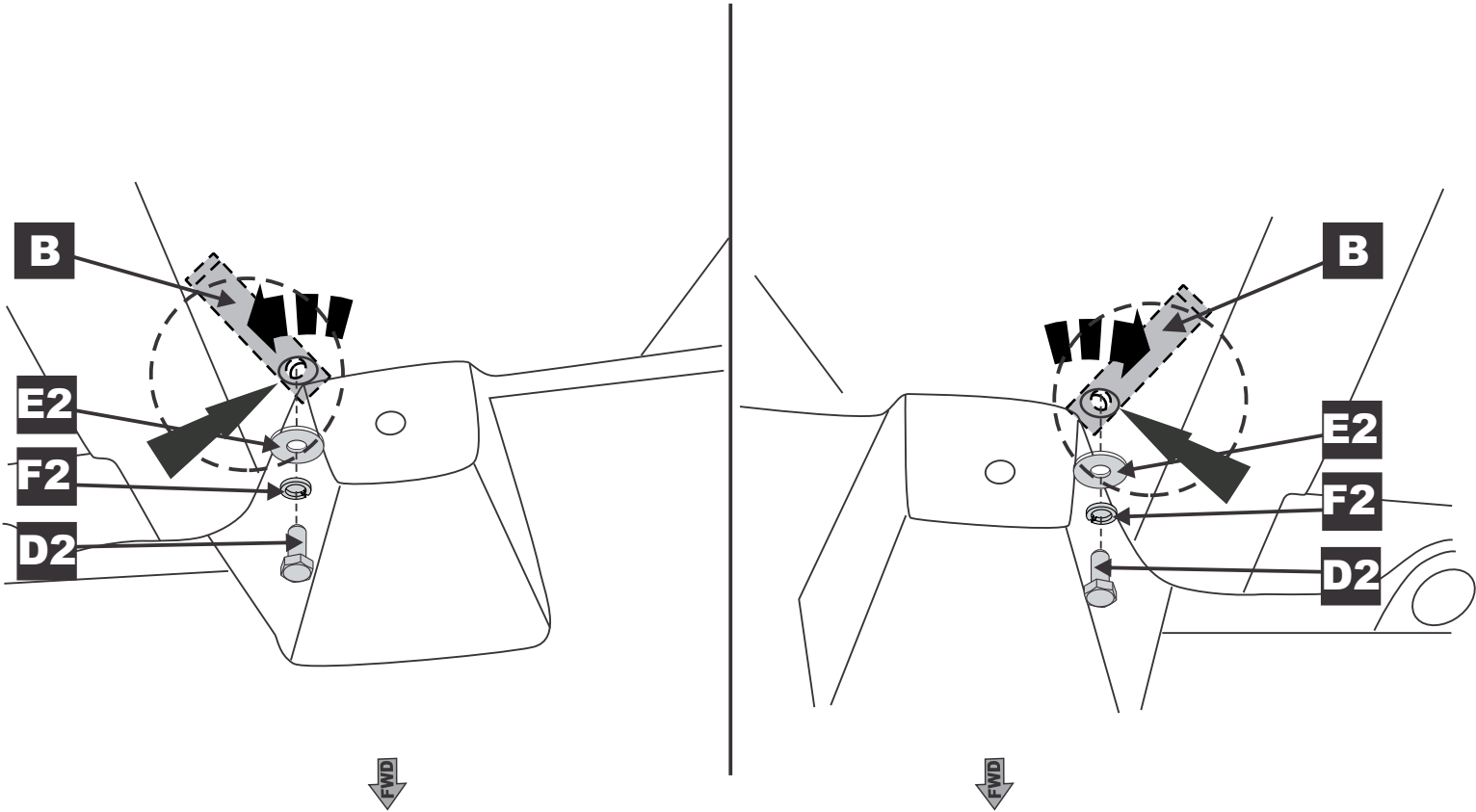

4

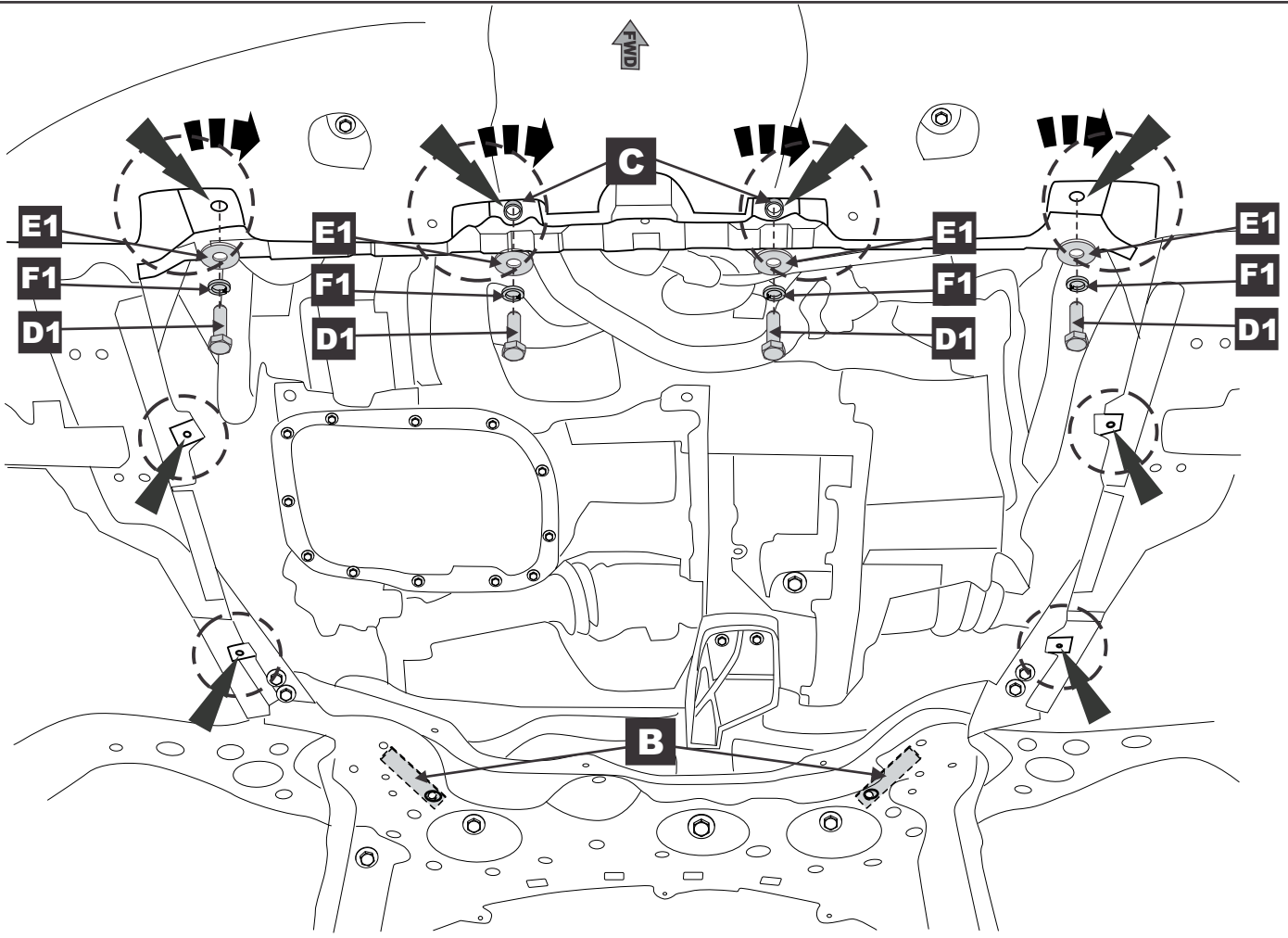

**5**

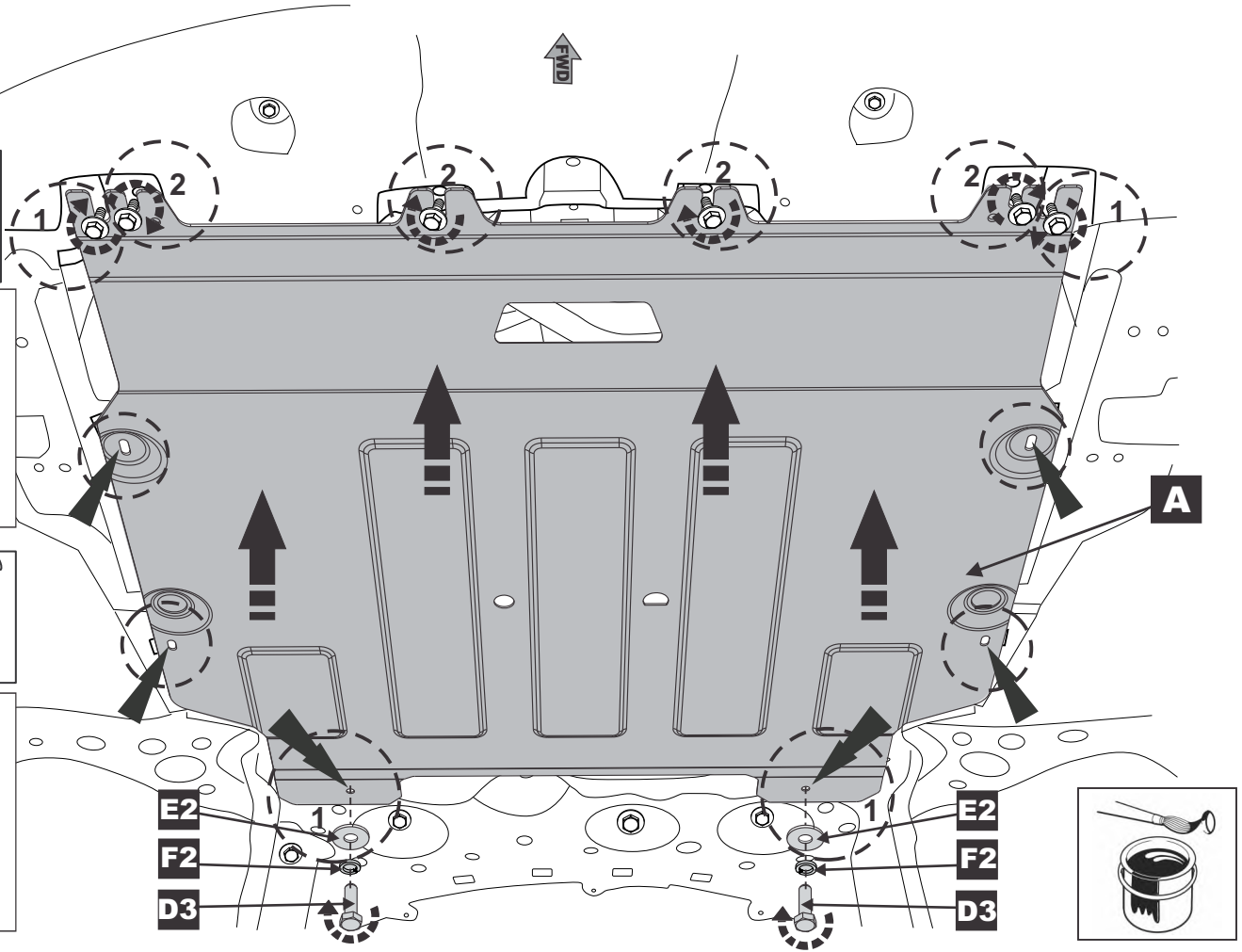
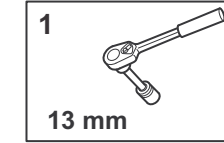
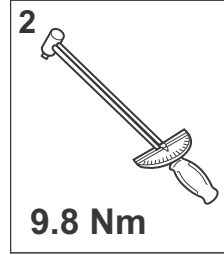
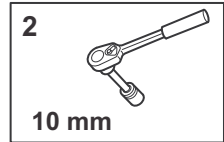

**6**

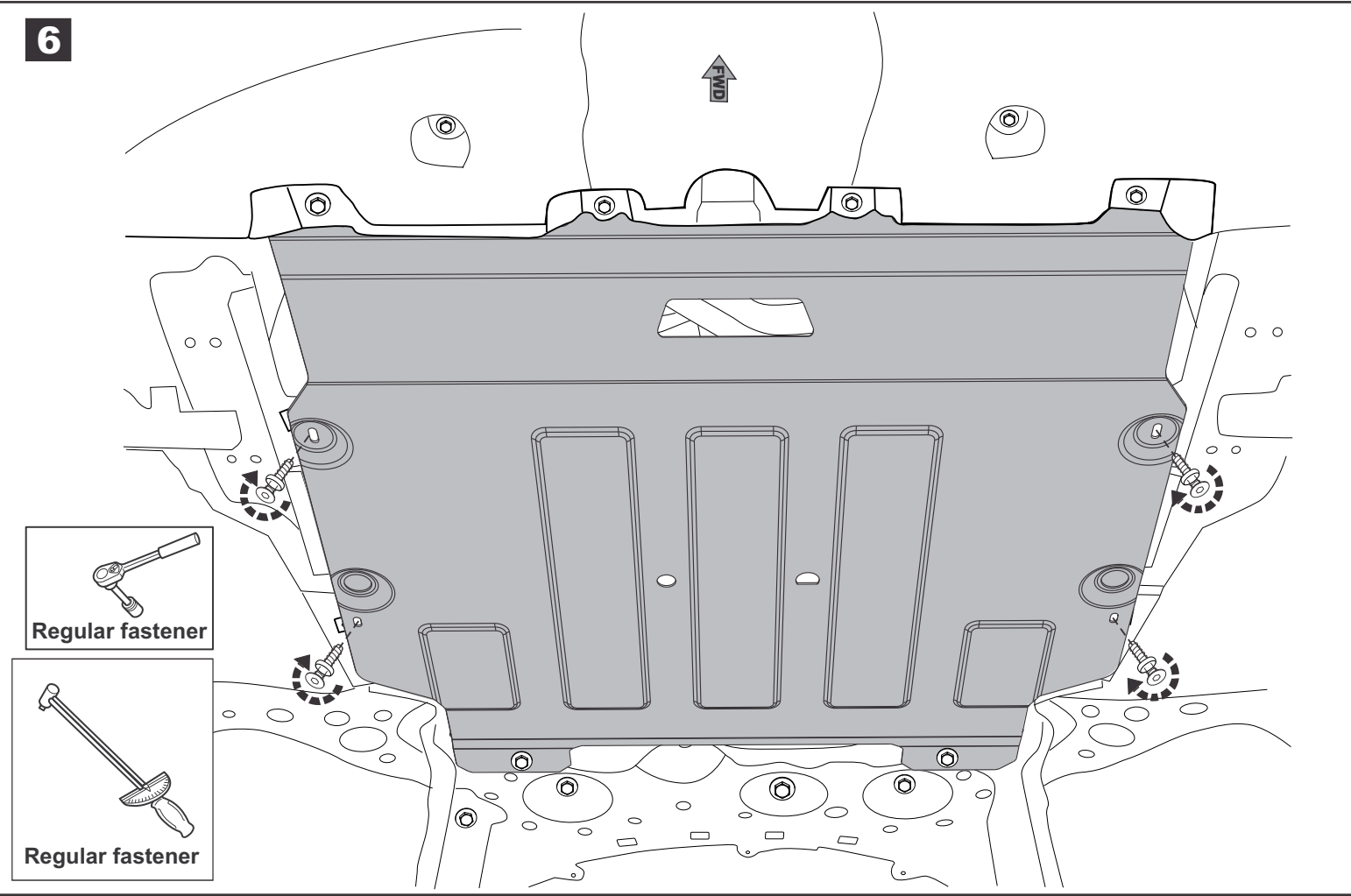
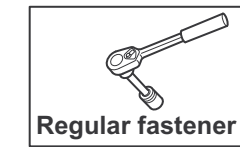

7

